

ALPHA LITE USER MANUAL BOOK



ALPHA SEVEN COLOR

ALPHA 2000



Precautions

[WARNING]

1

Do not open or disassemble the cover to reduce the risk of electric shock.

2

Please wear safety equipment such as safety helmet during work.

3

Be sure to fix the safety chain on the product when installing and moving.

4

Please install the signs below for people to bypass when install the product on high truss.

5

The work should be done under the direction of approved specialist who is trained in safety and mechanical installations.

6

The brightness and color temperature before and after aging may be different.

Contents

Safety Information	1
--------------------------	---

Fixture Information

Fixture Information	3
Fixture Exterior View	4
Dimensions	5
Accessory Options	6
Technical Specifications	7
Photometry Data	8

Fixture Installation

Power Connection	9
DMX Connection	10

LCD Screen Instruction

Unlocking	11
Screen Instruction	12
Menu Tree	13
Main Screen by Mode	14
& Product Information	
DMX Mode	15
(Channel Change & Address Setup)	
User Mode	16
(Intensity & Color Temperature & Tint Adjust)	
Color Mode	17
(RGB & Hue & Saturation & White Adjust)	

Extra Function

Sleep Mode Function	18
RDM Function	
Dimming Speed Setup	
Master Function	19
Fixture ID Number Setup	20
Device Label Setup	

Error Information

Temperature Sensor	21
Network Connection	

Extra Information

Cross Fader	22
Color Macro	

Protocols

DMX Protocols	23
RDM Protocols	26



Product name.

ALPHA 2000

The α7c series is the 3rd generation of LED lighting with a new light source/optical solution for lighting control and an innovative operation interface. It is a package lighting composed of LED spot / LED panel with 6 Color + 2 White ultra-high-capacity LED engine and ALPHA LITE's unique 'α Algorithm'.

Overcome the limits of the color expression gamut and color temperature range that existing White lighting and RGB lighting, it became possible to expression for Moonlight from Daylight-focused lighting, perfect color expression, and strong brightness at the same time.

⇒ CRI / TLCI Up to 99.5%

⇒ 2,000~35,000K Color temperature variable

⇒ Color correction function to adjust the emotional feeling and color of halogen lighting

Fixture Exterior View

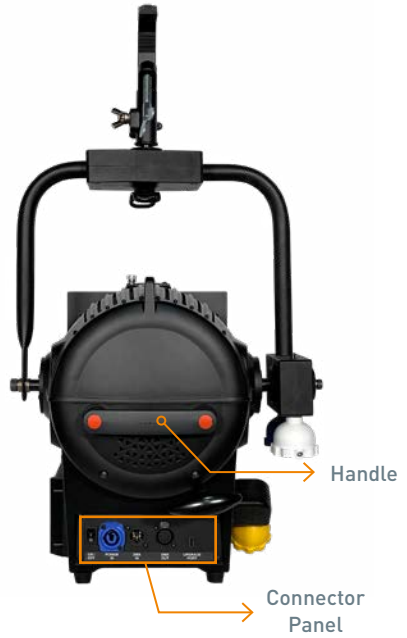

Dimensions

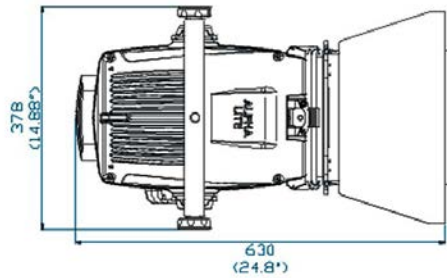
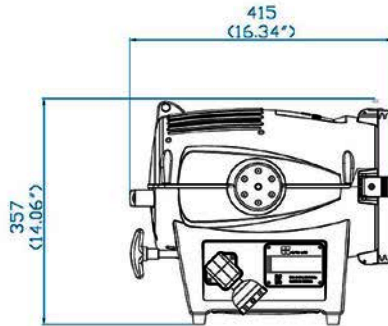
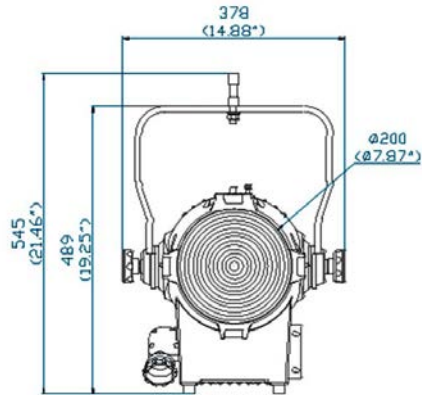

Accessory Options



Pole operation yoke

· Pan & Tilt



Jemball

· Detachable



Soft box

· Detachable

Technical Specifications

LED Chip Type	1100W 6 Color + 2 White LED engine
Estimated LED Lifetime (hours)	50,000
White Light (K)	2,000~35,000 (VCT/FCT)
Full Color Light	Full RGB + Amber + Lime + Cyan + Warm White + Cool White (7Color Gamut with Hue and Saturation Control)
Color Rendition (%)	CRI 95~99.5 / TLCI 95~99.5
Dimming (%)	0~100 (16-bit)
Lens Diameter (mm/inch)	200 / 7.9
Beam Angle (°)	15~55
Signal Control	5-Pin DMX In and Out
Individual Control	Smart Touch LCD Controller
Supported Protocol	DMX512 / RDM
(Optional) Supported Protocol	DMX512 Wireless / RDM Wireless
Remote Device Management	Supported
Channel Function	Dimming / CCT / Tint / RGBALC / Cross Fader / Color Macro / Strobe
Power Input Voltage	AC 100-240V / 50~60Hz
Power Consumption (W)	450
Ambient Temperature Operation (°C)	-20~45
Spigot Mounting (mm)	16 / 28
Tilt Angle (°)	+ / - 90
Body Dimensions (mm/inch) (WHD)	287 x 357 x 415 / 11.3 x 14.1 x 16.3
Full Dimensions with Manual Yoke (mm/inch) (WHD)	378 x 545 x 415 / 14.9 x 21.5 x 16.3
Body Weight (kg/lbs)	8.7 / 19.2
Full Weight with Manual Yoke (kg/lbs)	10 / 22
Protection Class	IP20

* This specification data is based on the aging state of the equipment, and the brightness and color temperature before and after aging may be different.

Photometry Data

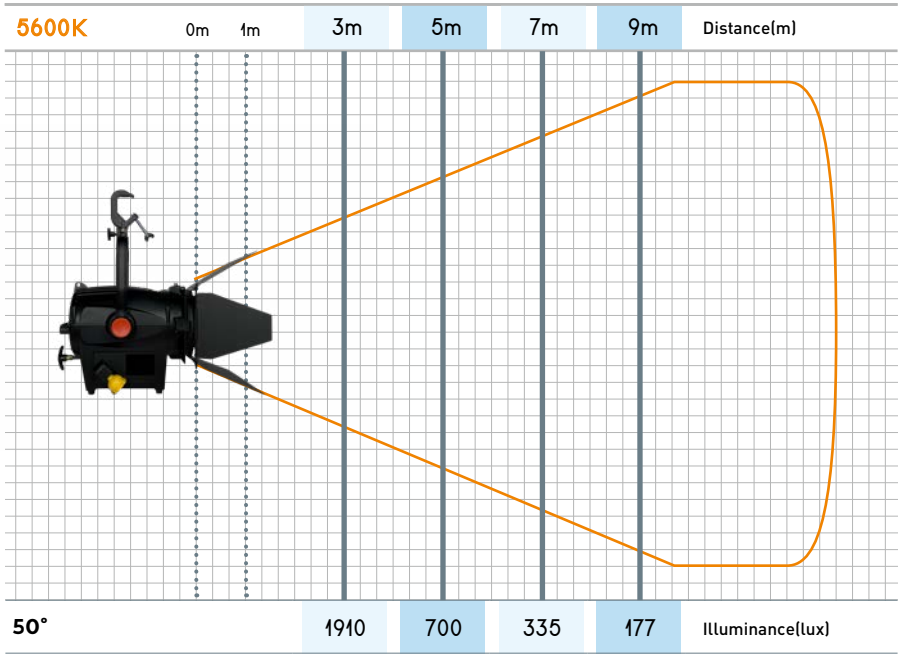

Power Connection

AC power at 100-240V, 50-60Hz

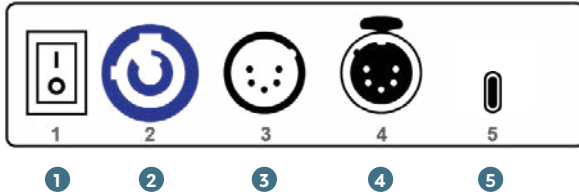

① POWER ON/OFF SWITCH

② POWER IN

③ DMX IN

④ DMX OUT

⑤ C-TYPE PORT
(for ADMINISTRATOR ONLY)

※ Do not connect USB without administrator's permission.

- ⚠ WARNING**
1. Observe the proper voltage rang.
 2. If power is supplied outside the range, noise may be generated from the SMPS.
 3. If the operating voltage is out of the proper voltage range, SMPS function may be degraded or damaged.

DMX Connection

3-pin or 5-pin XLR sockets are equipped for DMX input and output, depending on user needs.

Connect the controller to a lighting, or lighting fixture to other lighting fixture. If user uses a standard DMX controller, the DMX output of the controller can connect directly to the DMX input of the first fixture in the DMX chain.

User must use an adapter cable for connect the DMX controller to other XLR output.

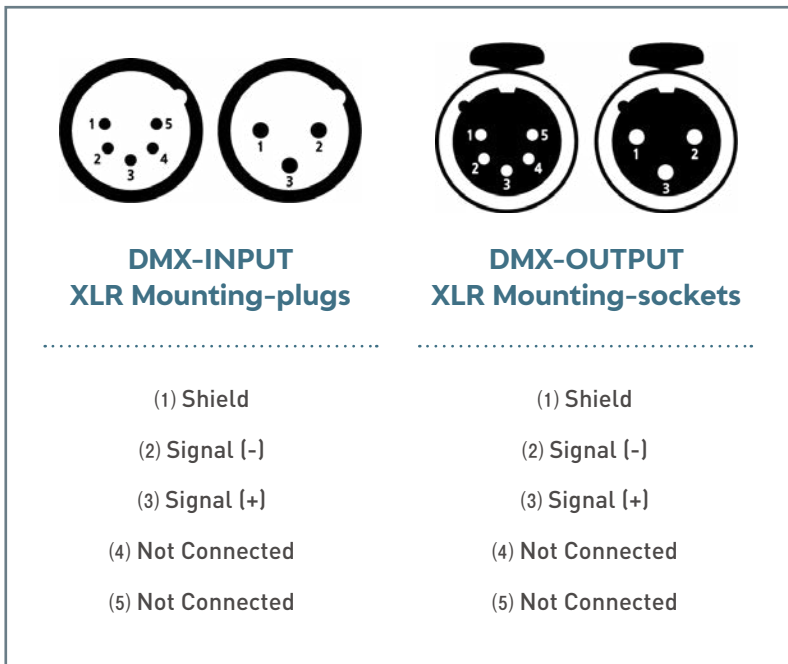

- ⚠ WARNING**
1. Connect the DMX output of the first lighting fixture in DMX chain to the DMX input of the next fixture.
 2. Connect one output to the input of the next fixture until all fixtures are connected.
 3. In the last lighting fixture, the DMX cable must be end with a terminator (120 Ω resistor) in DMX output signal (+, -).

Unlocking

When the fixture is turned on, the Smart Touch screen automatically locked. To unlock the touch screen, touch the finger icon (A) three times. If you do not touch for 30 seconds, the lock is reset.

[Main Screen (Locked)]

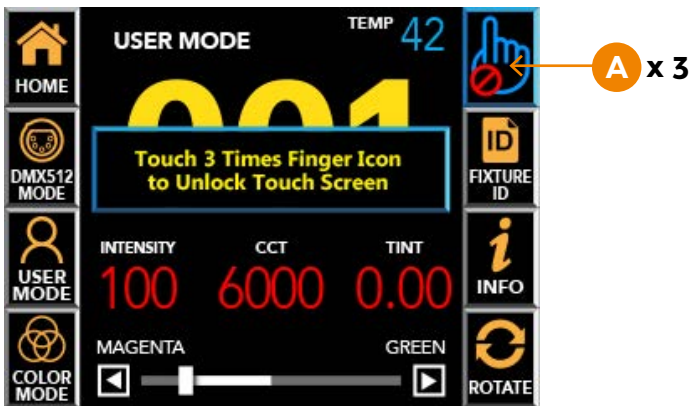

[Fixture ID Screen (Locked)]

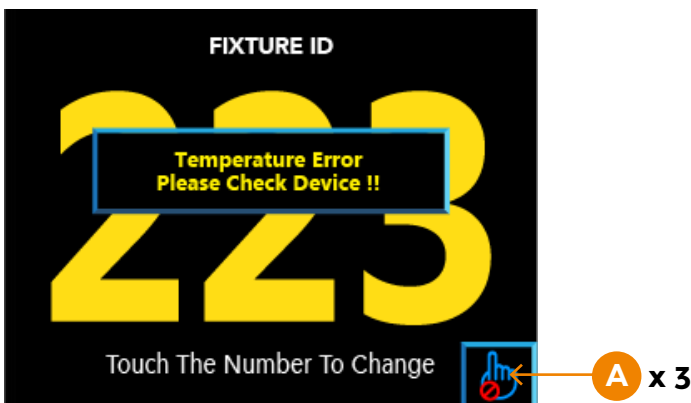

Screen Instructions

[Main Screen (Unlocked)]

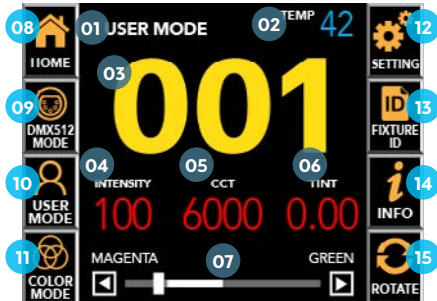

[Setting Screen]

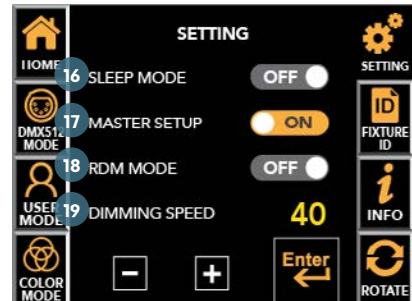

01	Current Mode	Display DMX MODE or USER MODE or COLOR MODE.
02	Fixture Current Temperature	The current temperature of the instrument is detected and displayed in °C.
03	DMX512 Address	Display current DMX512 Address.
04	Brightness (Intensity)	Displays the brightness value(0~100%) of the equipment.
05	CCT (Correlated Color Temperature)	Displays the color temperature(2000~35000K) of the equipment.
06	Tint(Gamma)	Displays the tint value(-1.00~+1.00) of the equipment.
07	(In USER MODE) Activated function control bar	Adjust the selected function among Intensity, Color Temperature and Tint.
	(In DMX MODE) Current channel mode	Display current channel mode. <i>*Only display on DMX MODE</i>
08	Home	Return to the main screen
09	DMX512 Mode & Address Setup	Set channel mode and DMX512 address
10	User Mode Setup	Set 'Intensity', 'CCT' and 'Tint' manually.
11	Color Mode Setup	Set 'RGB' lighting color, 'Saturation', and 'Intensity'
12	Setting	Setting or changing the function of the equipment.
13	Fixture ID	Displays numbers for equipment management.
14	Equipment Information	Displays the help that describes the screen.
15	Screen Rotation	LCD screen is rotated 180° for each touch.
16	Sleep Mode Setup	Activate and deactivate LCD Auto off function
17	Master Setup	Activate and deactivate Master function
18	RDM Mode Setup	Activate and deactivate RDM function
19	Dimming Speed Setup	Set dimming speed

Menu Tree

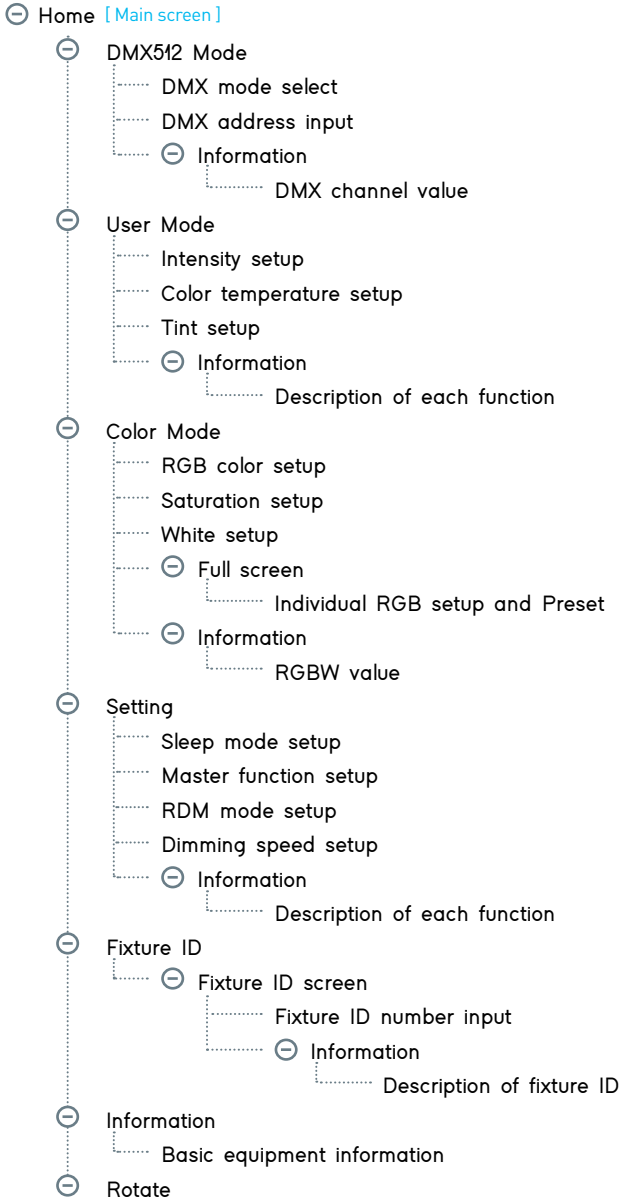

Main Screen by Mode & Product Information

001 Main Screen by Mode Information

HOME

DMX MODE

USER MODE

COLOR MODE

The current mode is displayed in the upper left corner of the main screen among DMX mode, user mode and color mode, and the DMX address number of the equipment is displayed in the middle with a yellow number. At the bottom, the current lighting value and fixture temperature are displayed, and some lighting value can be adjusted on the main screen by touching the value.

[DMX MODE]



[USER MODE]



[COLOR MODE]



Product Information

HOME

INFO

Product model name, firmware version, UID number, current temperature of equipment, usage time of equipment, LED usage time, website, manual download link, etc. by clicking the INFO button on the main screen.

Each 'MENU' ▶ Touch the 'INFO' ▶ User can check the menu description and functions.

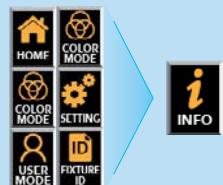

DMX Mode Channel Change & Address Setup

DMX MODE : It is used to adjust value by DMX512 signal.

HOME

DMX512 MODE

Move to the DMX channel change screen.

In DMX512 MODE screen, user can select DMX channel mode on top tap.

▶ Input DMX512 address by pressing the number pad.

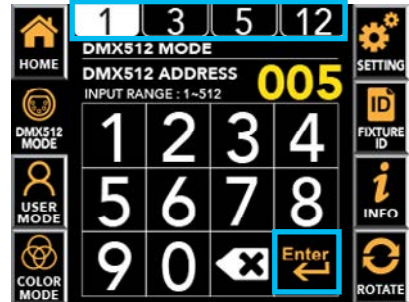
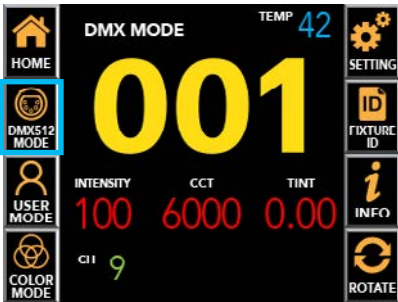

DMX512 MODE SCREEN

INFO

Displays each channel information and value.

※ To return to the previous screen, press the 'INFO' button again.

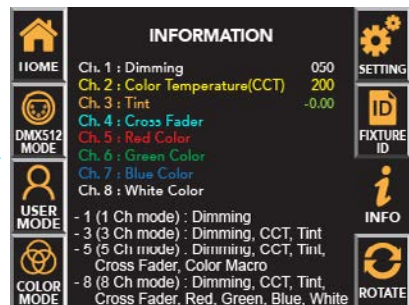
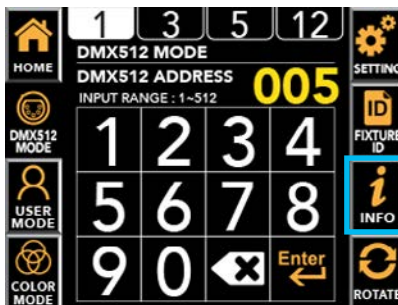

Information

- 1 (1 Ch Mode) : Dimming
- 3 (3 Ch Mode) : Dimming, CCT
- 5 (5 Ch Mode) : Dimming, CCT, Tint, Cross Fader, Color Macro
- 12 (12 Ch Mode) : Dimming, CCT, Tint, Cross Fader, Red, Green, Blue, Amber, Lime, Cyan, Color Macro, Strobe

* Support channels and features vary by product.

User Mode Setup & Intensity / CCT / Tint Adjust

USER MODE : It is used when the user directly manipulates the equipment.

HOME

USER MODE

Move to user-operable screen to change Intensity/CCT/Tint.

OR

'Current Intensity'
'Current CCT'
'Current Tint'

Activate control bar and adjust value directly according to selected function.

※ In DMX mode, even if you press the current value on the main screen, the bottom bar is not active.

USER MODE screen ▶ Touch the function you want to change ▶ **Active in Orange** ▶ Adjust the value with touch or drag.

Drag the activated bar close to the desired value, and then touch \uparrow , \downarrow to set the exact value.

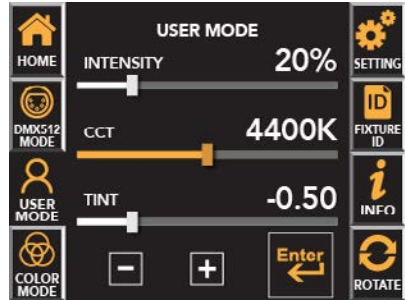
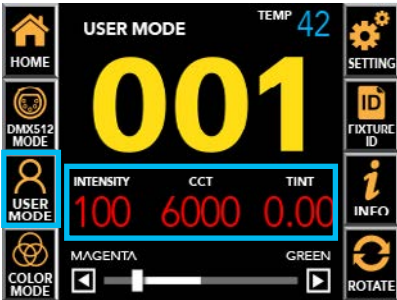

USER MODE SCREEN

INFO

Displays description of each function.

※ To return to the previous screen, press the 'INFO' button again.

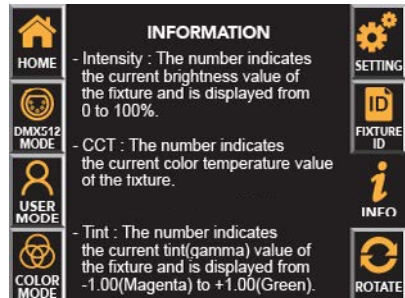
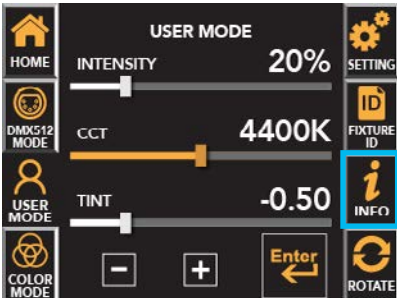

Information

- Intensity : The number indicates the current brightness value of the fixture and is displayed from 0 to 100%.
- CCT : The number indicates the current color temperature value of the fixture and is displayed from 2,000~35,000Kelvin.
- Tint : The number indicates the current tint(Gamma) value of the fixture and is displayed from -1.00(Magenta) to +1.00(Green).

Color Mode Setup & RGB / Hue / Saturation / White Adjust

COLOR MODE : It is used when the user directly manipulates the equipment.

HOME → COLOR MODE → Move to user-operable screen to change Hue/Saturation.

COLOR MODE screen ▶ Touch the function you want to change ▶ **Active in Orange** ▶ Adjust the value with touch or drag.

- Individual RGB value adjustment and saving preset (#1~9) can be specified through the [] button.
- Fine adjustment of RGB values and the number of presets can be changed through the up, down, left and right arrows.

After adjusting the desired value, press 'Enter' ▶ It returns to the COLOR MODE screen.

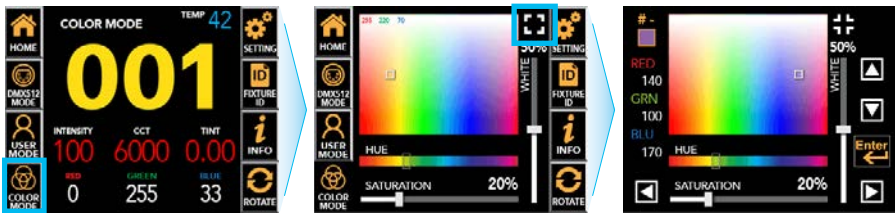

COLOR MODE SCREEN →

INFO →

Displays description of each function.

※ Press the INFO button again to return to the 'COLOR MODE' screen.

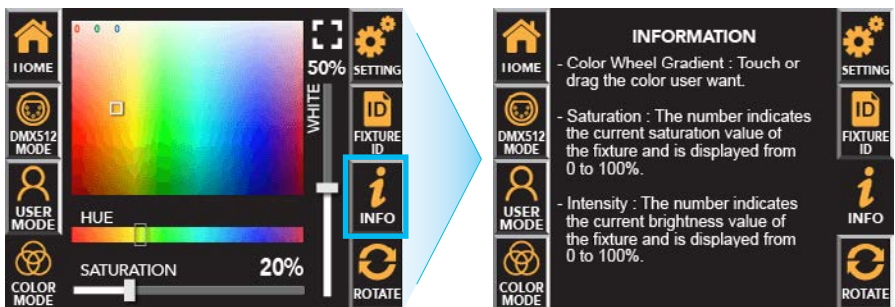

Information

- **Color Wheel Gradient** : Touch or drag the color user want
- **Hue** : Drag and select the Hue user want.
- **Saturation** : The number indicates the current saturation value of the fixture and is displayed from 0 to 100%.
- **White** : The number indicates the current White LED brightness value of the fixture and is displayed from 0 to 100%.

Extra Function

- Sleep Mode / Master / RDM / Dimming Speed

HOME

SETTING

Move to additional settings other than the main icon.

SETTING screen ▶ Touch ON/OFF the function you want to change among SLEEP MODE, MASTER and RDM MODE ▶ **Active in Orange** ▶ Set ON/OFF

- DIMMING SPEED SETUP can be activated by touching, and press **+**, **-** to adjust the value.

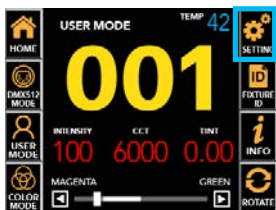

SETTING SCREEN

INFO

Displays description of each function.

※ Press the INFO button again to return to the setting screen.

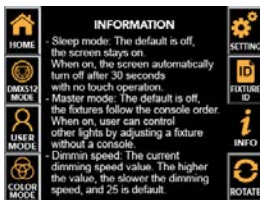

Information

- **Sleep mode setup (Default=Off)** The function to automatically turn off the screen when there is no operation for 30 seconds. If OFF, it is always on the screen while power is on.
- **Master setup (Default=Off)** The function to synchronize and user control all connected fixtures without a console connection. If OFF, the DMX signal will follow.
- **RDM setup (Default=On)** The function to enable two-way wireless communication through RDM equipment. If OFF, it is not detected by RDM equipment.
- **Dimming speed setup** The number indicates the current dimming speed value of the fixture and is displayed from 0 to 40. The higher the value, the slower the dimming speed, and '15' is default speed

Extra Function

- Sleep Mode / Master / RDM / Dimming Speed

Master Setup

- The master slave function allows to synchronize and control all connected lighting fixtures through the DMX signal without a console connection.
- If a problem occurs in the console or communication line, it is possible to control the brightness and CCT and color with only the lighting fixture.
- Main screen ► Setting ► Touch MASTER SETUP, the function turns on. (2 Touch)
- Functions available with one setting of the first lighting fixture.

[Main Screen]

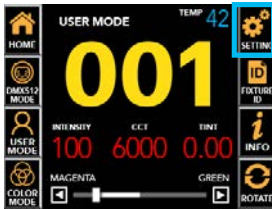

[Fixture ID Screen]

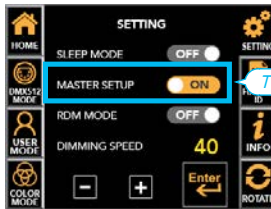

ex

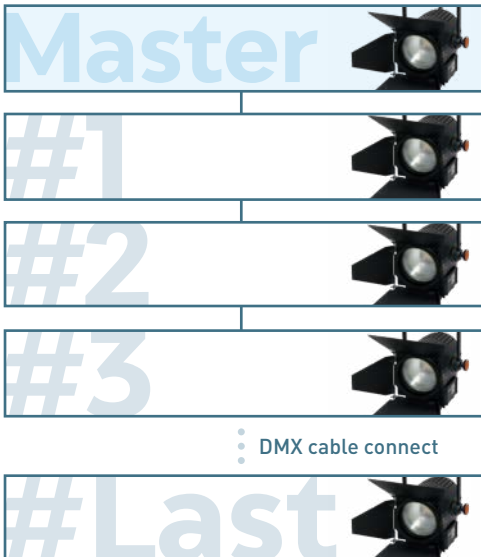

- Remove 'DMX in' cable.
- Set '**Master Enable**'
- Set the same channel mode.
- Operation After setting.

- Connecting 'DMX in & out' cable.
- Set '**Master Disable**'
- Set the same channel mode.
- No operation after setting.

Fixture ID & Label Setup

HOME

FIXTURE ID

Move to fixture management number setting screen.

Move to input screen that can change the number ▶ Input the desired number 001 to 9999 and press Enter ▶ Move to the FIXTURE ID screen that displays the large size entered value ▶ Touch HOME icon to go back to the main screen.

[Main Screen]

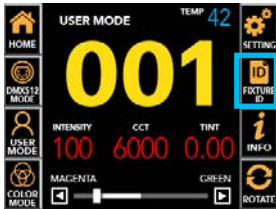

[Fixture ID Screen]



[Fixture ID Input Screen]

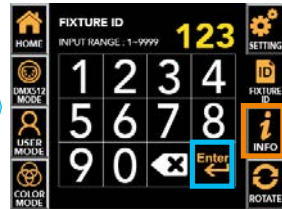

Fixture ID
Input
Screen

INFO

Displays description of each function.

※ It is the number value 001 to 9999 for the management of the lighting fixture can be changed by manual or RDM device.

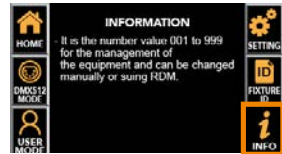

[Device Label Setup]



[Change the device label through RDM]

《 The device label is basically the model name. It can be changed through RDM communication, but it can't be changed through the Smart Touch LCD 》

Enter the device name and the management number in the 'Device Label' field. ▶ The entered contents are displayed in the upper left corner.

- The fixture ID is displayed in 3 or 4 digits from automatically recognized 4 digits in contents.
- If user do not enter any number, the fixture ID is displayed as '001'.

	ex 1	ex 2	ex 3	ex 4	ex 5
Input(Device Label in RDM)	SPOT123	SPOT1234	SPOT12345	SPOT	STUDIO13-23
Fixture Label(in Fixture)	SPOT123	SPOT1234	SPOT12345	SPOT	STUDIO13-23
ID Number(in Fixture)	123	1234	2345	001	023

Error Information

Temperature Sensor

Detects the temperature of the current fixture(LED source, housing) and displays it on the Smart Touch LCD screen.



If it exceeds 85°C, the actual LED output will be 0%, and

“Temperature Error!!”

“Please Check Device!!”

will be displayed.

The error messages are only displayed on the main screen and the fixture ID screen. Even if the temperature falls to the normal range, It does not disappear.

In this case, normalize the temperature of the equipment and restart it.

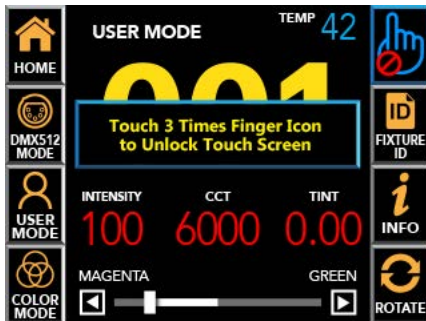

Network Connection

When the DMX512 network connection is lost, the DMX512 address number on main screen and the fixture ID screen blinks. Reconnect after checking the connection status.

Cross Fader & Color Macro

Cross Fader

[In 5 or 12 channel mode]

- When the DMX value of Ch.4(Cross Fader) is 0, the color temperature set by Ch.2(CCT) is distributed.
- When the DMX value of Ch.4 is 255, only color set by Ch.5(Color Macro in 5 Channel Mode) or Ch.5~11(Red, Green, Blue, Amber, Lime, Cyan and Color Macro in 12 Channel Mode) is distributed.
- In 12 channel mode, the last set color among Ch.5~10(Individual color settings) and Ch.11 (Color Macro) is applied and distributed.
- As the DMX value of Ch.4 increase, the brightness of Ch.2 decrease and the brightness of the color set by Ch.5 or Ch.5~11 increase at the same time.
- The DMX value of Ch.4 adjusts the CCT and color brightness and density ratio relative to each other.

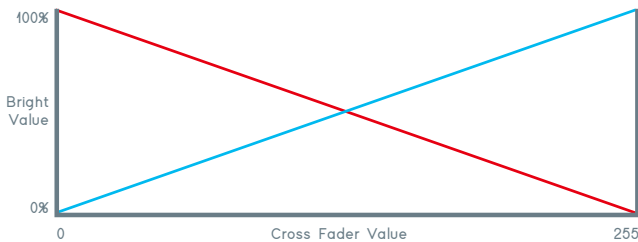

Color Macro

Color Macro(Ch.5 in 5 channel mode, Ch.11 in 12 channel mode) is rainbow gradation effect.

The order is

RED

>

GREEN

>

BLUE

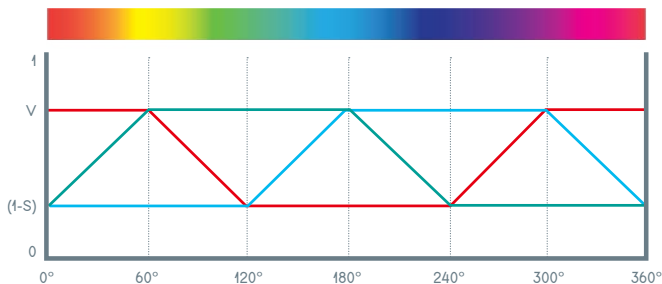

DMX Protocols (1/4) Channel Mode

Mode	Channel	DMX Value	%	Function
1	1	0-255	0-100	Dimmer

Mode	Channel	DMX Value	%	Function
3	1	0-255	0-100	Dimmer
	2	0-255	See DMX Protocols (2)	Color Temperature (CCT)
	3	0-119 / 120-255	See DMX Protocols (3)	Tint

Mode	Channel	DMX Value	%	Function
5	1	0-255	0-100	Dimmer
	2	0-255	See DMX Protocols (2)	Color Temperature (CCT)
	3	0-119 / 120-255	See DMX Protocols (3)	Tint
	4	0-255	0-100	Cross Fader
	5	0-255	See DMX Protocols(4)	Color Macro

Mode	Channel	DMX Value	%	Function
12	1	0-255	0-100	Dimmer
	2	0-255	See DMX Protocols (2)	Color Temperature (CCT)
	3	0-119 / 120-255	See DMX Protocols (3)	Tint
	4	0-255	0-100	Cross Fader
	5	0-255	0-100	Red
	6	0-255	0-100	Green
	7	0-255	0-100	Blue
	8	0-255	0-100	Amber
	9	0-255	0-100	Lime
	10	0-255	0-100	Cyan
	11	0-255	See DMX Protocols (4)	Color Macro
	12	0-255		Strobe

DMX Protocols (2/4)

3 & 5 & 12 Channel Mode : Color Temperature

DMX Value	Function	DMX Value	Function	DMX Value	Function	DMX Value	Function	DMX Value	Function
0	2000	50-51	3950	101	5450	151-152	7400	202	12000
1-2	2100	52	4000	102-103	5500	153	7500	203-204	12500
3-4	2200	53-54	4050	104-105	5550	154-155	7600	205-206	13000
5	2300	55-56	4100	106	5600	156-157	7700	207	13500
6-7	2400	57	4150	107-108	5650	158	7800	208-209	14000
8-9	2500	58-59	4200	109-110	5700	159-160	7900	210-211	14500
10	2600	60-61	4250	111	5750	161-162	8000	212	15000
11-12	2700	62	4300	112-113	5800	163-164	8100	213-214	15500
13-14	2800	63-64	4350	114-115	5850	165	8200	215-216	16000
15	2900	65-66	4400	116	5900	166-167	8300	217	16500
16-17	2950	67-68	4450	117-118	5950	168-169	8400	218-219	17000
18-19	3000	69	4500	119-120	6000	170	8500	220-221	17500
20	3050	70-71	4550	121	6050	171-172	8600	222	18000
21-22	3100	72-73	4600	122-123	6100	173-174	8700	223-224	18500
23-24	3150	74	4650	124-125	6150	175	8800	225-226	19000
25	3200	75-76	4700	126	6200	176-177	8900	227-228	19500
26-27	3250	77-78	4750	127-128	6250	178-179	9000	229	20000
28-29	3300	79	4800	129-130	6300	180	9100	230-231	21000
30	3350	80-81	4850	131-132	6350	181-182	9200	232-233	22000
31-32	3400	82-83	4900	133	6400	183-184	9300	234	23000
33-34	3450	84	4950	134-135	6450	185	9400	235-236	24000
35-36	3500	85-86	5000	136-137	6500	186-187	9500	237-238	25000
37	3550	87-88	5050	138	6600	188-189	9600	239	26000
38-39	3600	89	5100	139-140	6700	190	9700	240-241	27000
40-41	3650	90-91	5150	141-142	6800	191-192	9800	242-243	28000
42	3700	92-93	5200	143	6900	193-194	9900	244	29000
43-44	3750	94	5250	144-145	7000	195-196	10000	245-246	30000
45-46	3800	95-96	5300	146-147	7100	197	10500	247-248	31000
47	3850	97-98	5350	148	7200	198-199	11000	249	32000
48-49	3900	99-100	5400	149-150	7300	200-201	10500	250-251	33000
								252-253	34000
								254-255	35000

DMX Protocols (3/4)

3 & 5 & 12 Channel Mode : Color Macro

DMX Value	Color Value	Color Macro
1 - 6		
7 - 12		
13 - 18		
19 - 24		
25 - 30		
31 - 34		
35 - 38		
39 - 42		
43 - 46		
47 - 50		
51 - 54		
55 - 58		
59 - 62		
63 - 66		
67 - 70		
71 - 74		
75 - 78		
79 - 82		
83 - 86		
87 - 90		
91 - 94		
95 - 98		
99 - 102		
103 - 106		
107 - 110		
111 - 114		
115 - 118		
119 - 122		
123 - 126		
127 - 130		

DMX Value	Color Value	Color Macro
131 - 134		
135 - 138		
139 - 142		
143 - 146		
147 - 150		
151 - 154		
155 - 158		
159 - 162		
163 - 166		
167 - 170		
171 - 174		
175 - 178		
179 - 182		
183 - 186		
187 - 190		
191 - 194		
195 - 198		
199 - 202		
203 - 206		
207 - 210		
211 - 214		
215 - 218		
219 - 222		
223 - 226		
227 - 230		
231 - 234		
235 - 238		
239 - 242		
243 - 246		
247 - 250		
251 - 255		

DMX Protocols (4/4)

3 & 5 & 12 Channel Mode : Tint / 12 Channel Mode : Strobe

[Tint]

Mode	DMX Value	Output Value	Function
3	0~10	0	No Effect
	11~20	(-)1.00	Full Magenta
	21~119	(-)0.99 ~ (-)0.01	99~1% Magenta
	120~145	0	No Effect
	146~244	(+)0.01 ~ (+)0.99	1~99% Green
	245~255	(+)1.00	Full Green

[Strobe]

DMX Value	Channel
0	Neutral / No effect
1~255	1 / Slow ~ 255 / Fast

RDM Protocols (1/3)

Parameter ID	Discovery command	SET command	GET command
DISC_UNIQUE_BRANCH	YES		
DISC_MUTE	YES		
DISC_UN_MUTE	YES		
DEVICE_INFO			YES
SUPPORTED_PARAMETERS			YES
SOFTWARE_VERSION_LABEL			YES
DMX_START_ADDRESS		YES	YES
IDENTIFY_DEVICE		YES	YES
DEVICE_MODEL_DESCRIPTION			YES
MANUFACTURER_LABEL			YES
DEVICE_LABEL		YES	YES
SENSOR_DEFINITION			YES
SENSOR_VALUE			YES
DMX_PERSONALITY		YES	YES
DMX_PERSONALITY_DESCRIPTION			YES
STATUS_MESSAGES			YES

RDM Protocols (2/3)

No	Device Property	Value (Example)	Description	User Setting	Remarks
1	Device Model Description	ALPHA 2000	Model number of the device	Disable	
2	Manufacturer Label	ALPHA LITE	Name of the manufacturer	Disable	
3	Device Label	SPOT123	Fixture name and management number	Enable	ex) Input : SPOT123 · Name : SPOT123 · Management # : 123 - Automatic recognition of up to 4 digits. If there is no number, the default is '001'.
4	Software Version Label	M0E-v1.10-v5.27-180928	Software version	Disable	
5	DMX Personality	1 Ch. Mode	DMX channel mode and color temperature setting	Enable	See (Table 1)
6	DMX Start Address	1	DMX address	Enable	1-512 Range
7	Device Hours	N/A		N/A	Display only, no actual response.
8	Lamp Hours	N/A		N/A	Display only, no actual response.
9	Lamp State	N/A		N/A	Display only, no actual response.
10	Lamp On Mode	N/A		N/A	Display only, no actual response.
11	Display Invert	On	LCD screen display direction	Enable	· Off : 0° · On : 180° · Auto : Current opposite direction
12	Identify Device	Off	Selected fixture blinking indication	Enable	· Off : Deactivates blinking · On : Activates blinking
13	Speed Set	15	Dimming delay Setting	Enable	0-40 range The larger the value, the slower the dimming.
14	Display Mode	0	Normal screen / Fixture ID screen transitions	Enable	· 0 : Normal screen · 1 : Fixture ID screen
15	Max. Temp	75	Fixture maximum temperature display	Enable	Use for initialization if necessary

[Lamp Controls]

No	Control Property	Value (Example)	Description	User Setting	Remarks
1	Identify On	N/A	Device identification action active	Enable	Identify device = Same as On
2	Identify Off	N/A	Device identification action inactive	Enable	Identify device = Same as Off
3	Cold Reset	N/A	Device reset(restart)	Enable	Same as Warm reset
4	Warm Reset	N/A	Device reset(restart)	Enable	Same as Cold reset

RDM Protocols (3/3)

[Sensor]

No	Device Sensors	Value (Example)	Description	User Setting	Remarks
1	Sensor Temp	64°C	Current fixture temperature	Disable	

[Error Message]

No	Condition	Level	Description	Display
1	Sensor Over Temp	Warning	Fixture temperature 46 ~ 69°C	Orange message
2	Sensor Over Temp	Error	Fixture temperature over 70°C	Red message

[Table 1]

Model	Value	Description
12 Ch. Model Device (Variable Color Temperature & RGBALC)	1 Ch. Mode	1 Ch. Mode
	3 Ch. Mode	3 Ch. Mode
	5 Ch. Mode	5 Ch. Mode
	12 Ch. Mode	12 Ch. Mode
	1 Ch. 2000K	1 Ch. Mode + 2000K Color Temperature
	1 Ch. 2500K	1 Ch. Mode + 2500K Color Temperature
	1 Ch. 2900K	1 Ch. Mode + 2900K Color Temperature
	1 Ch. 3200K	1 Ch. Mode + 3200K Color Temperature
	1 Ch. 4000K	1 Ch. Mode + 4000K Color Temperature
	1 Ch. 5000K	1 Ch. Mode + 5000K Color Temperature
	1 Ch. 5600K	1 Ch. Mode + 5600K Color Temperature
	1 Ch. 6000K	1 Ch. Mode + 6000K Color Temperature
	1 Ch. 10000K	1 Ch. Mode + 10000K Color Temperature
	1 Ch. 30000K	1 Ch. Mode + 30000K Color Temperature
	1 Ch.35000K	1 Ch. Mode + 35000K Color Temperature



ALPHA LITE USER MANUAL BOOK

—

<Tel> 82-2-6317-0464

<Fax> 82-2-2039-0464

<E-mail> hello@alpha-lite.net

<Web> www.alpha-lite.net